

Thank you for downloading my  
free Easter printables!

If you enjoyed them, please  
consider subscribing to my  
YouTube channel:

This Southern Girl Can

These images are free for you to  
print and use, but may not be  
reproduced and sold.

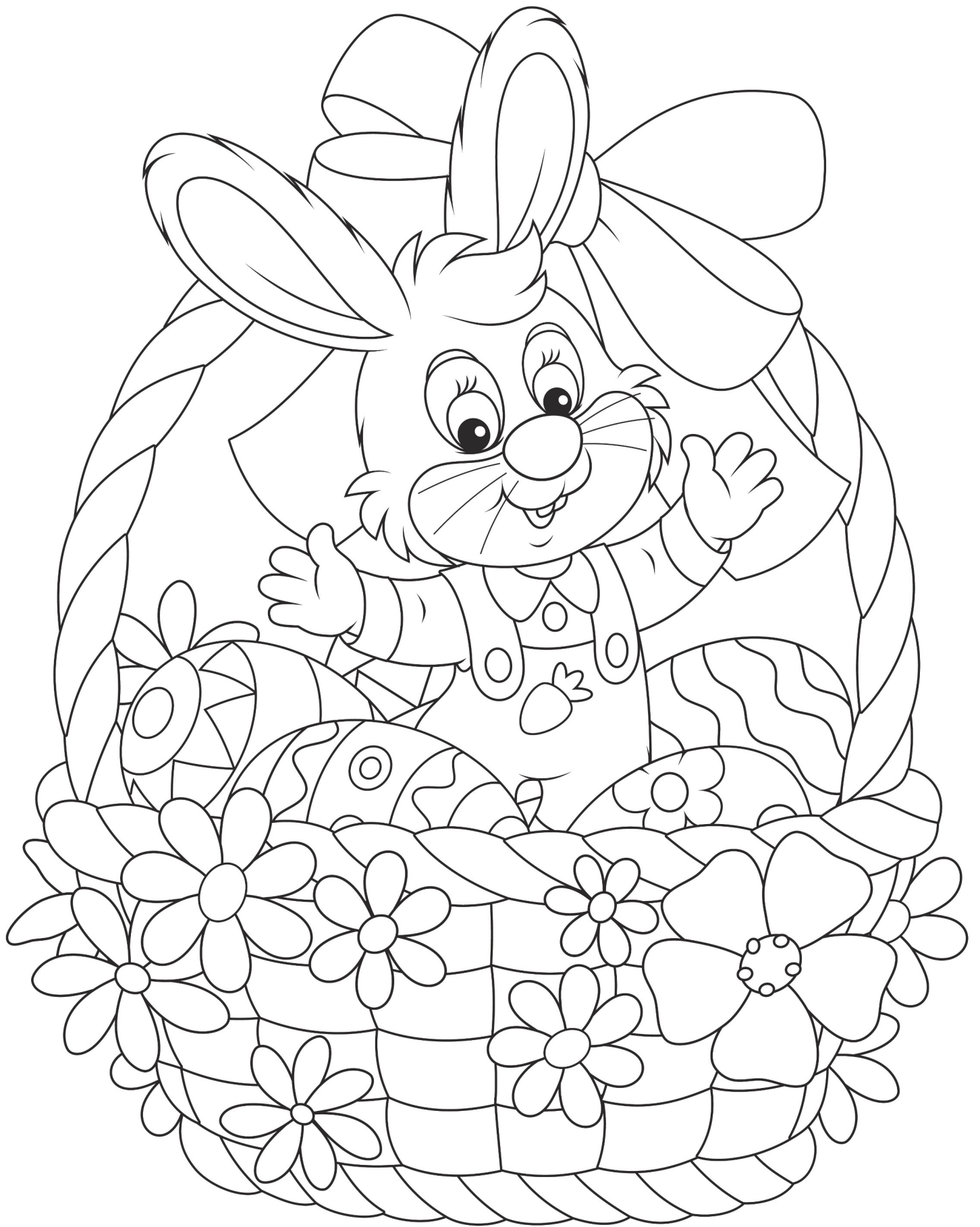



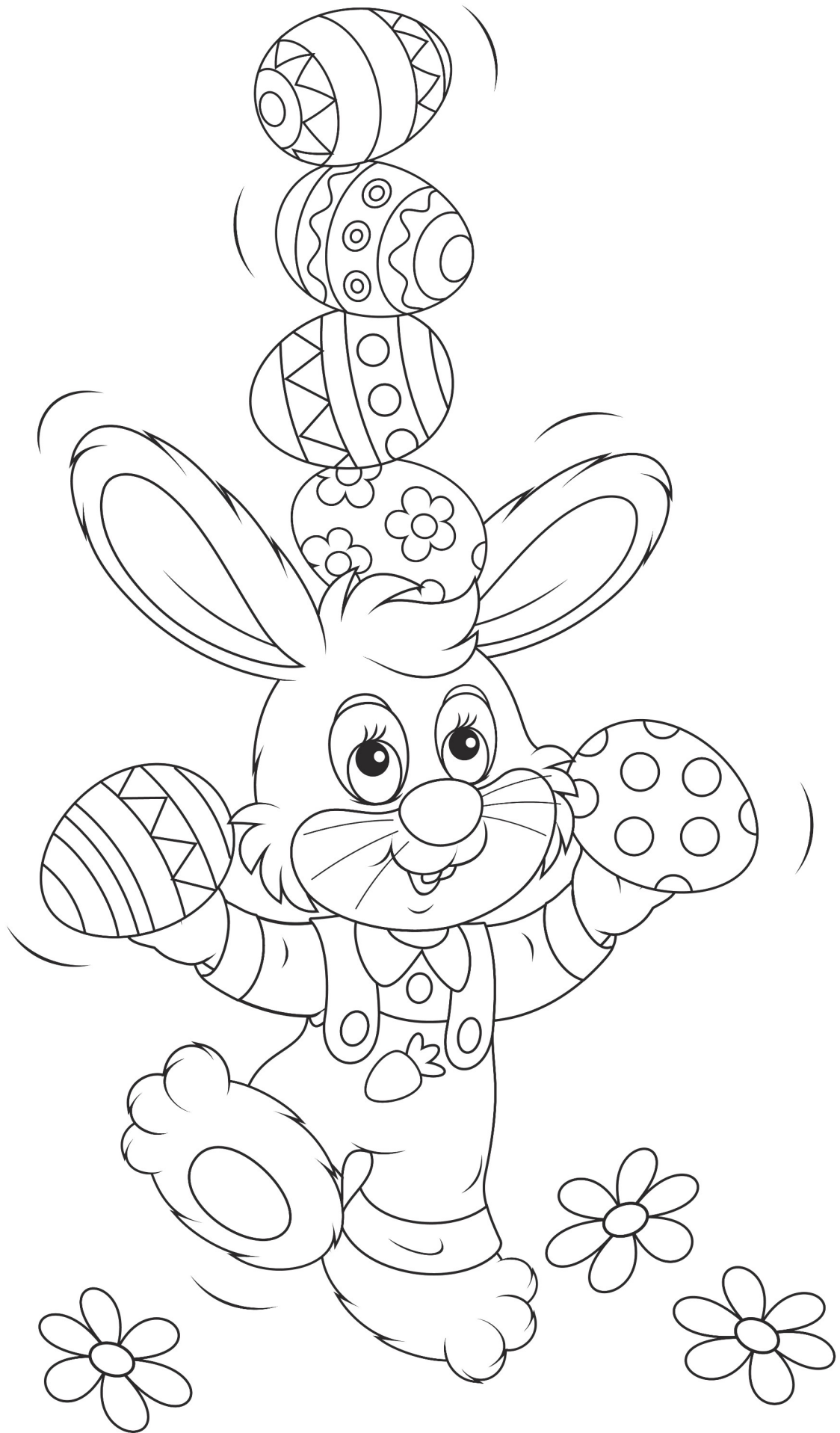

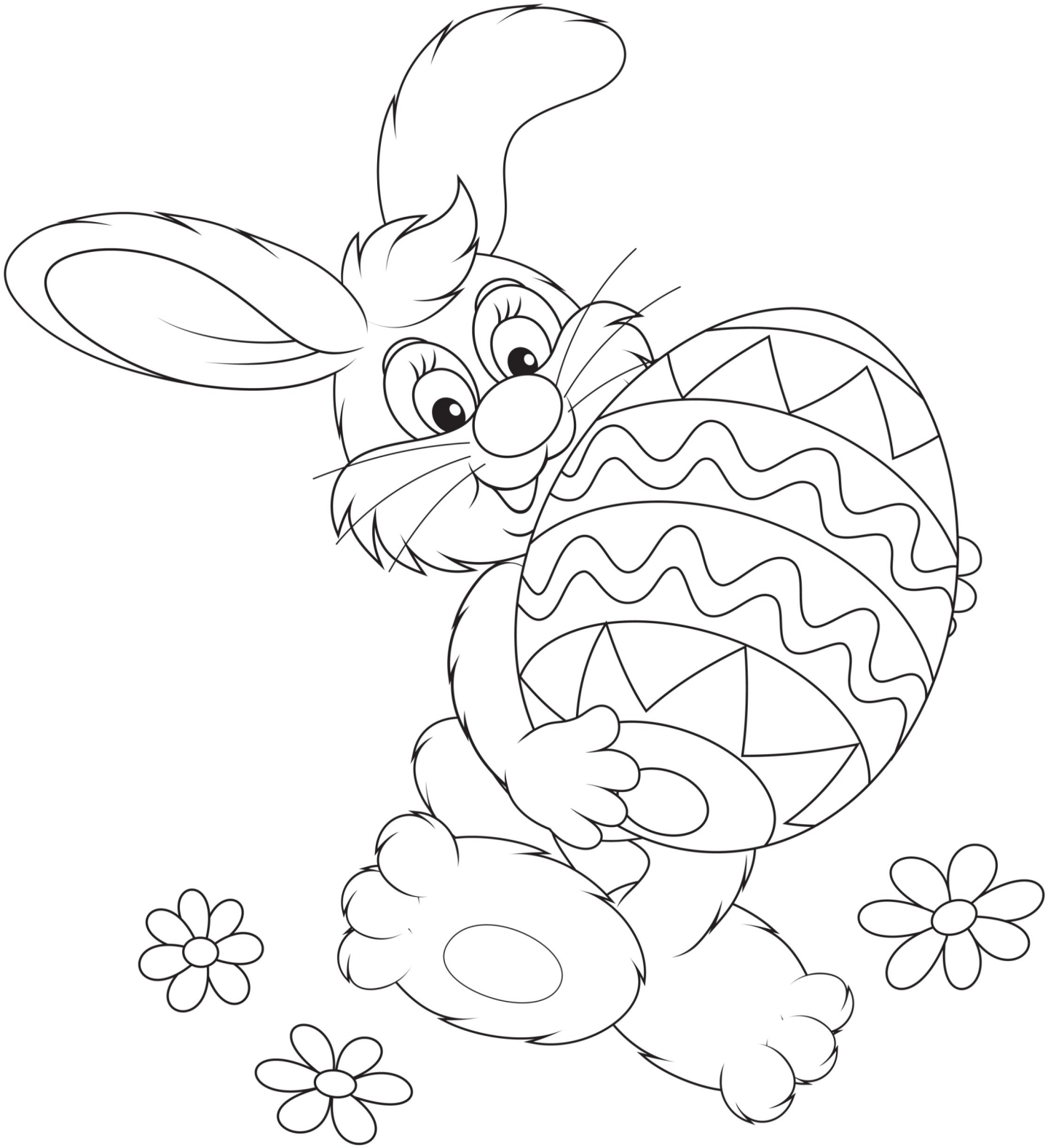













# Alphabet Tracing Practice

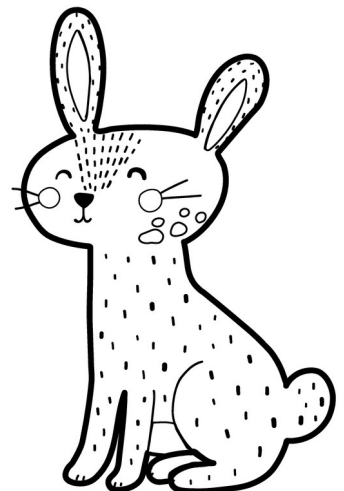
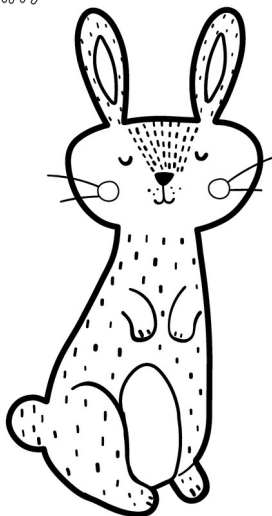
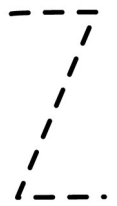
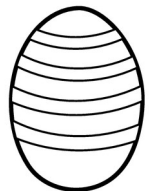
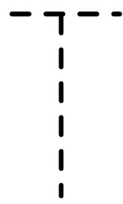
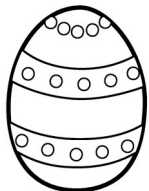
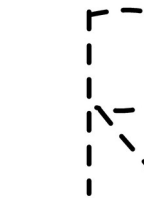
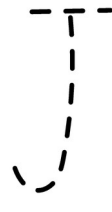
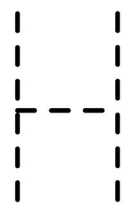
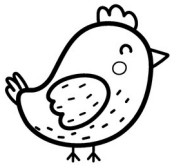
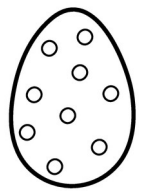
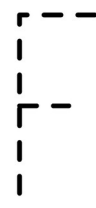
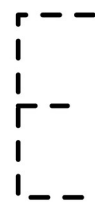
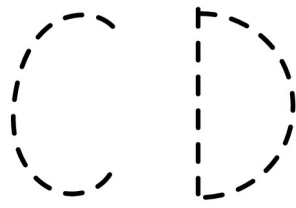

Help the cute chick to find  
Easter eggs

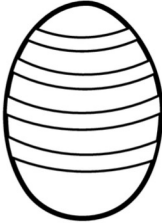
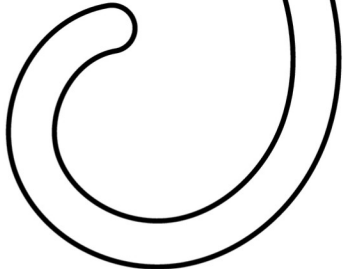
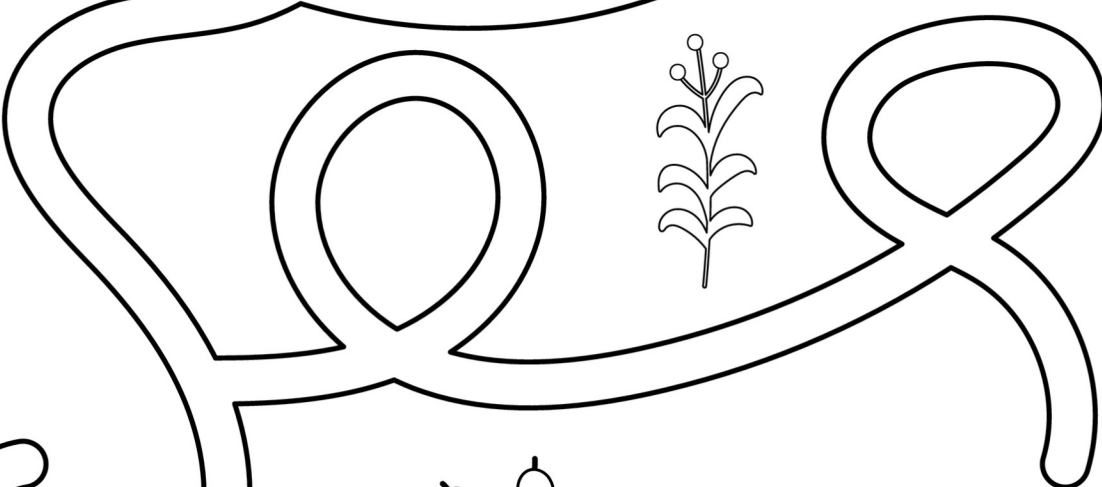
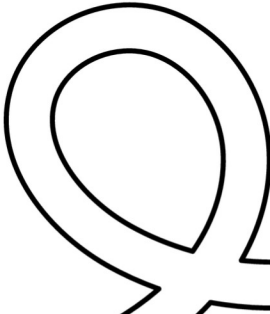
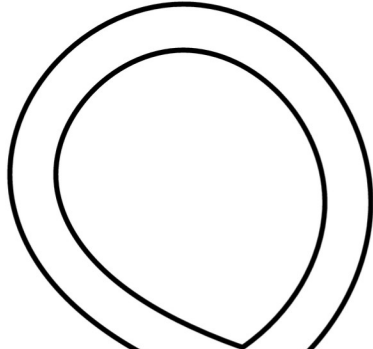
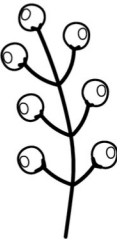
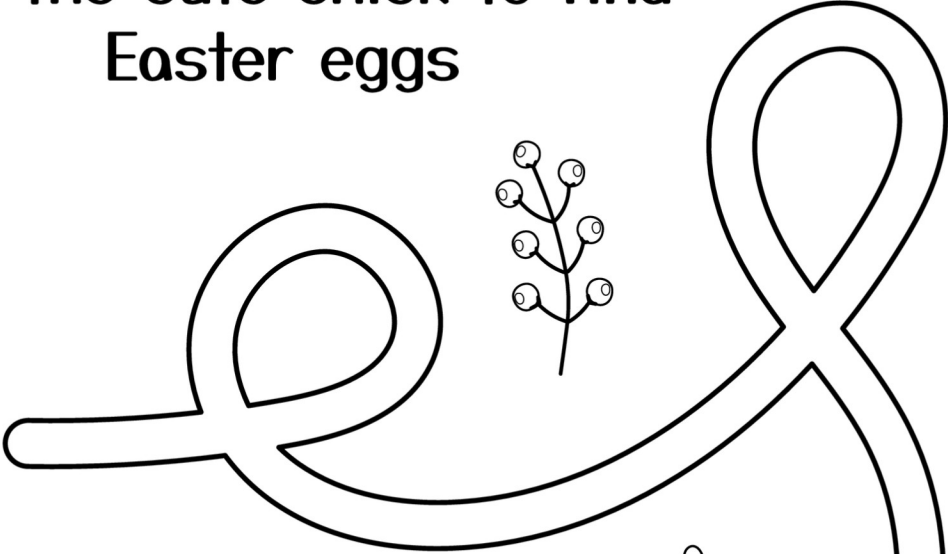
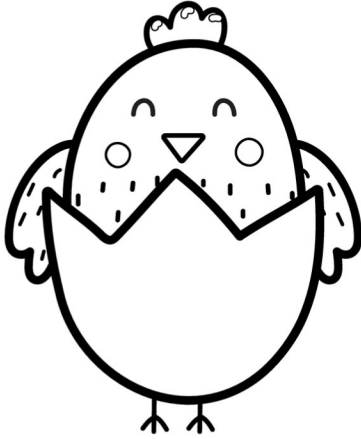

# How Many?

Count and trace the numbers

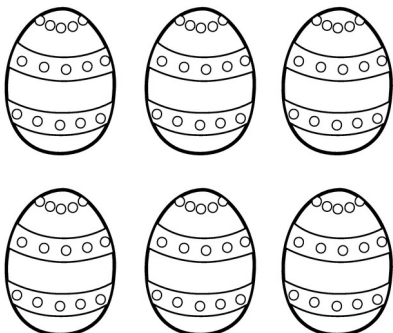
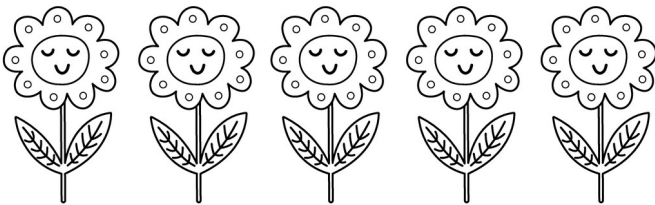
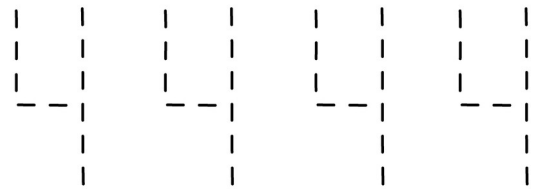
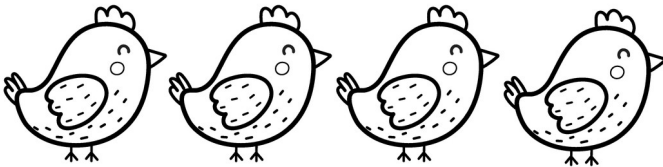
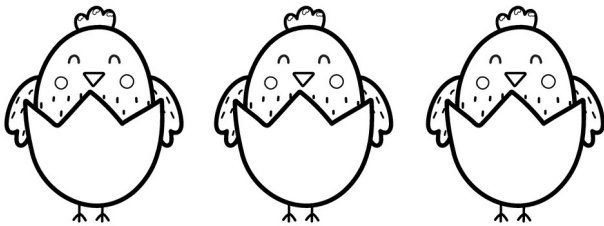
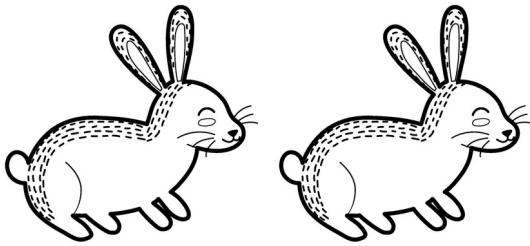
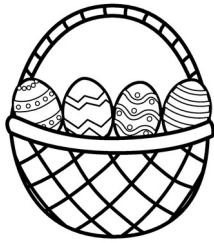



# Spot 10 differences

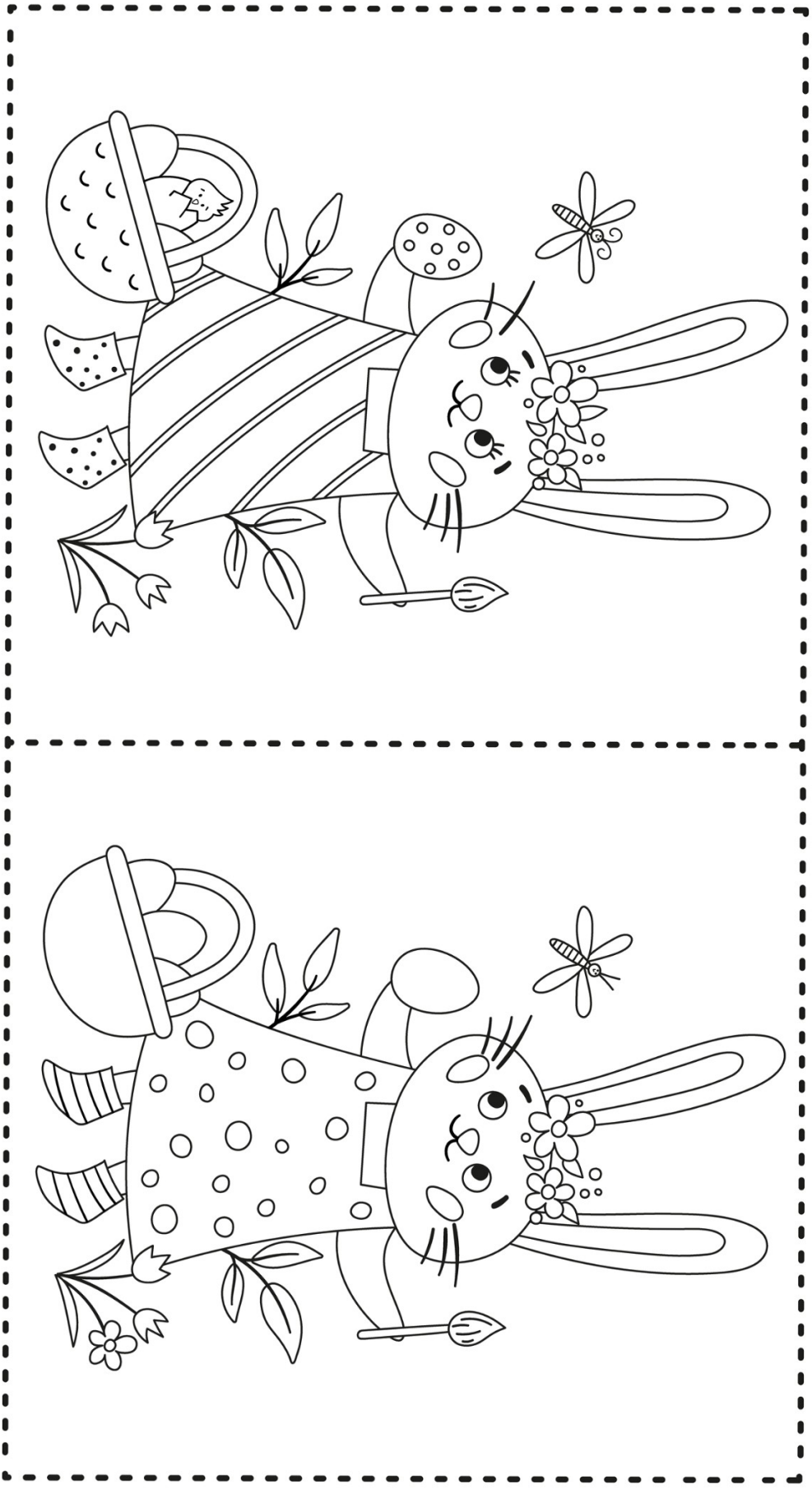
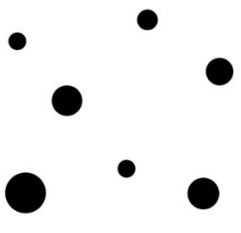



HELP THE RABBIT GET TO THE CASE WITH CARROTS

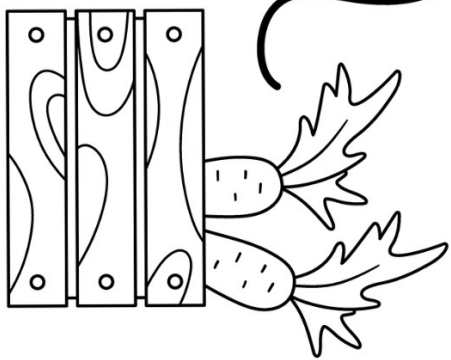
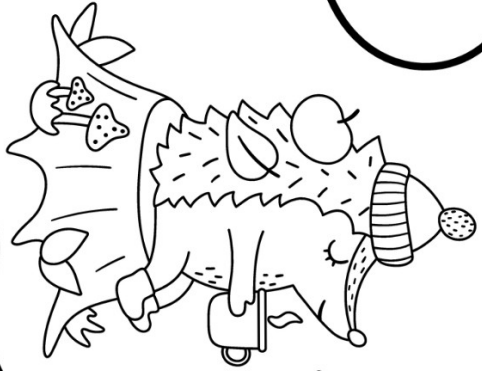
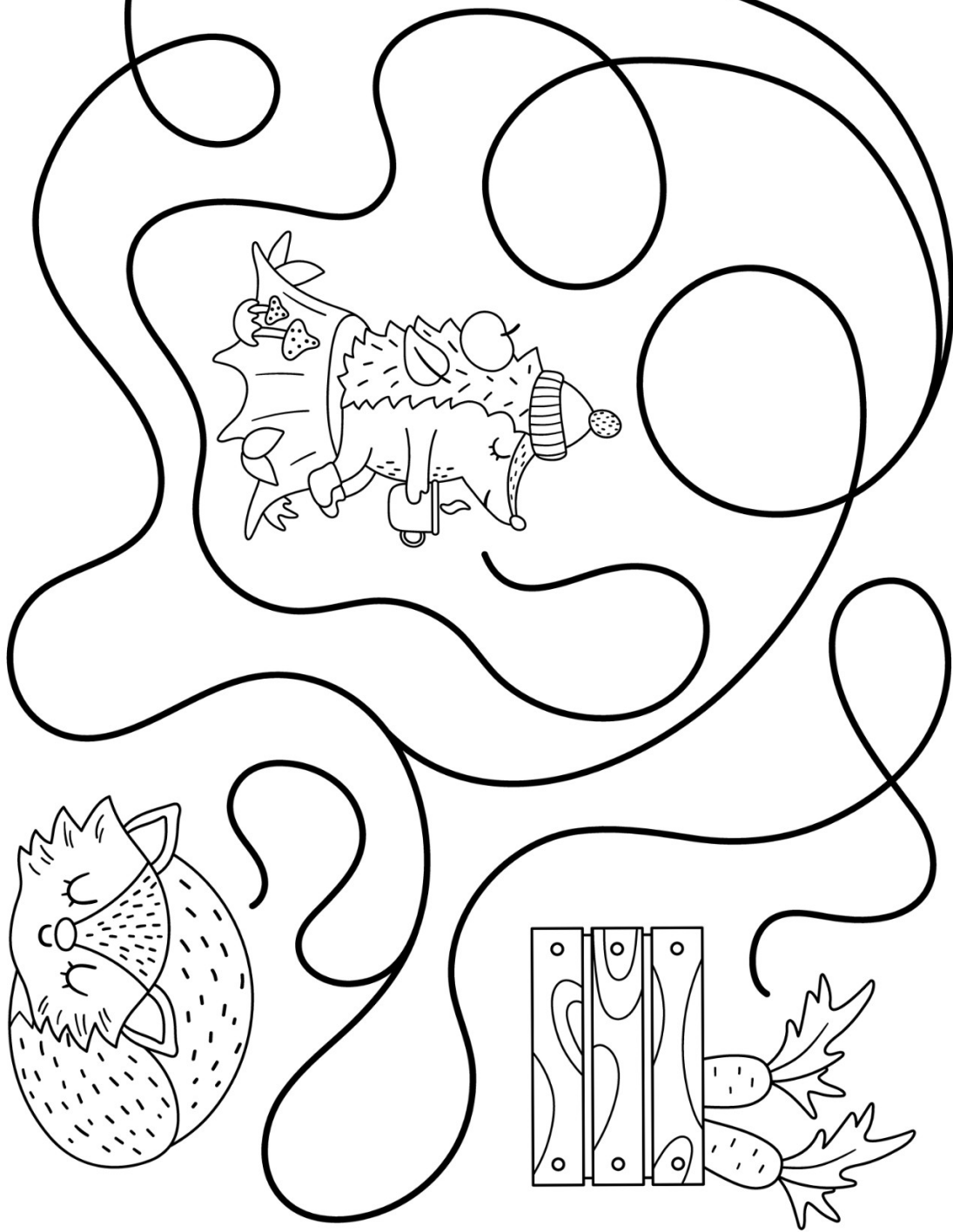
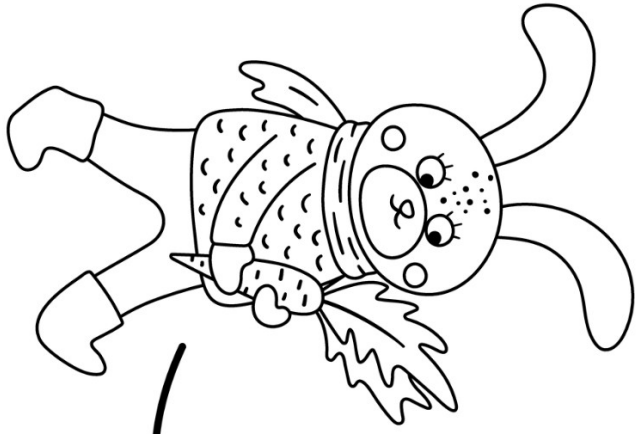
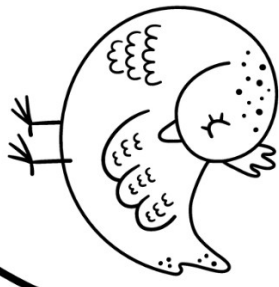



# HOW MANY CARROTS?

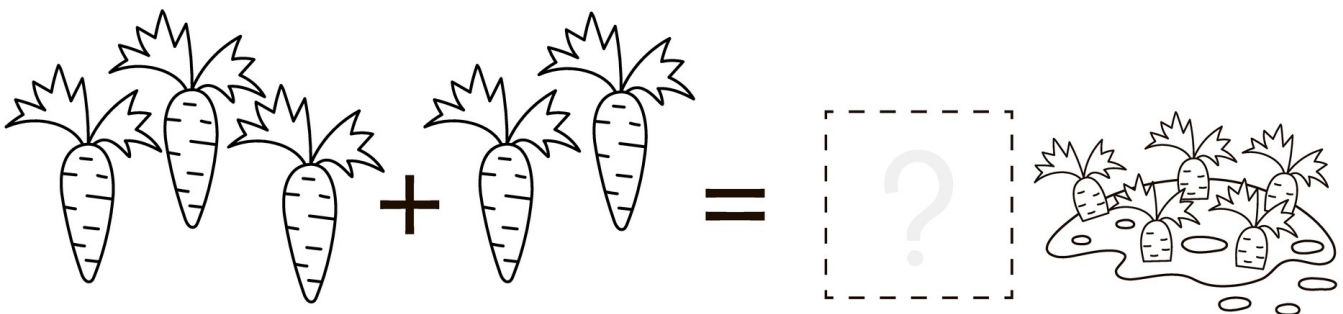
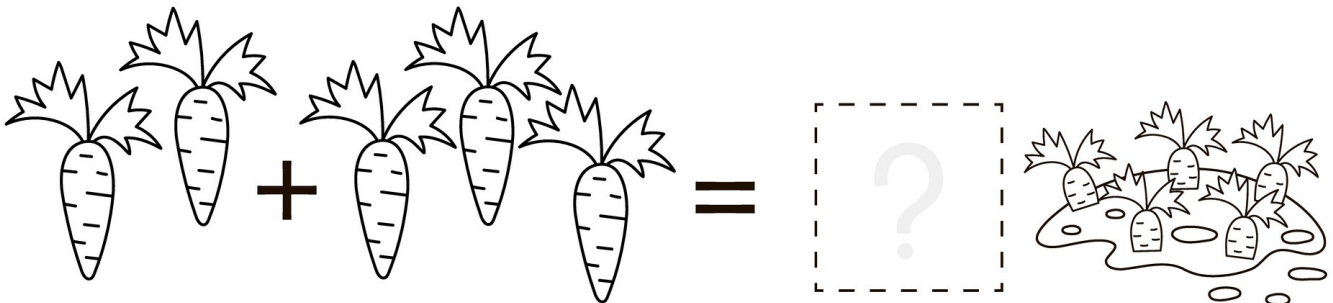
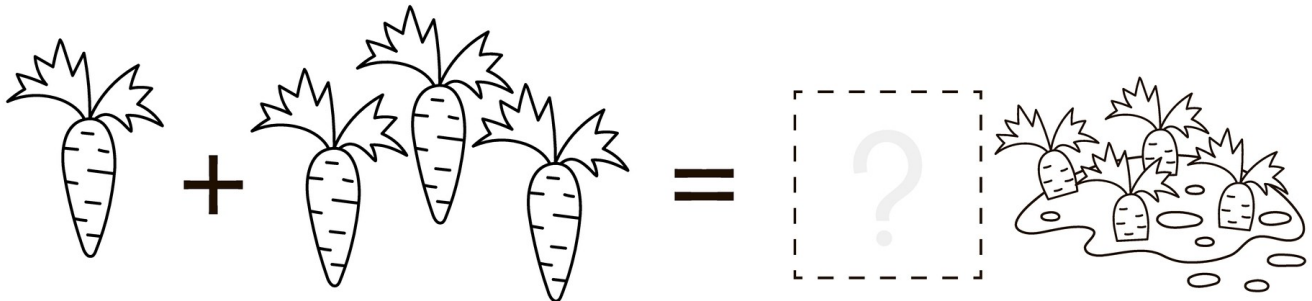
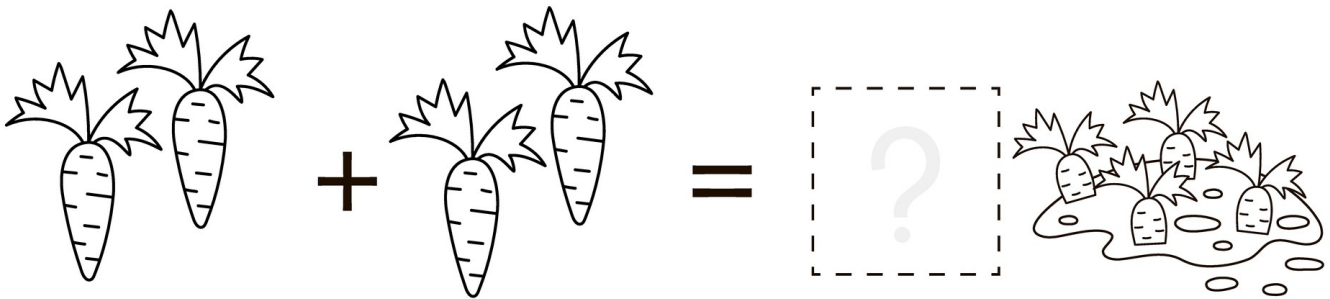
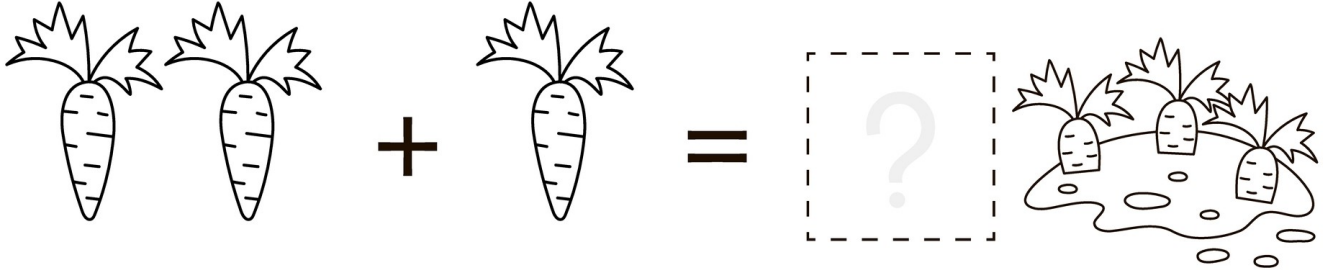
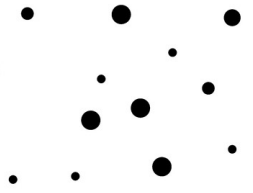





# EASTER SHADOW MATCHING

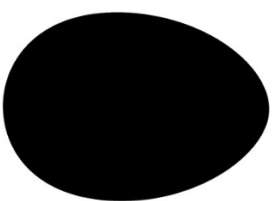
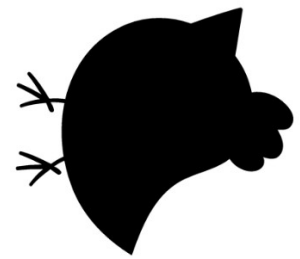
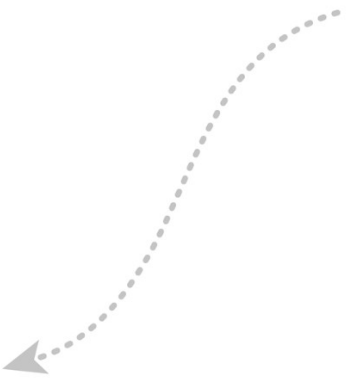
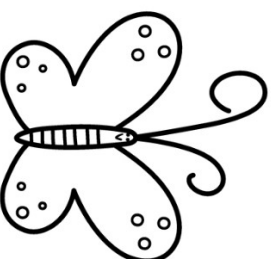
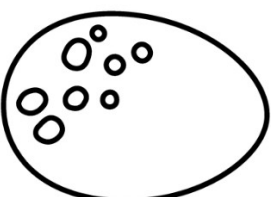
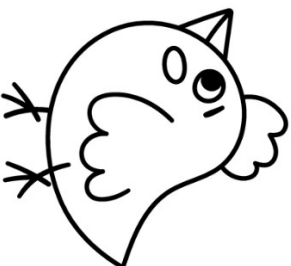
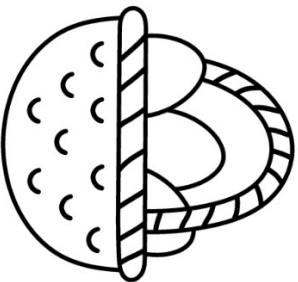
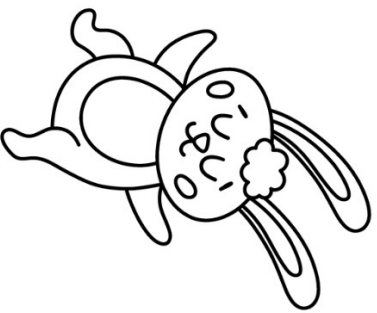



# WHOSE EASTER TREATS?

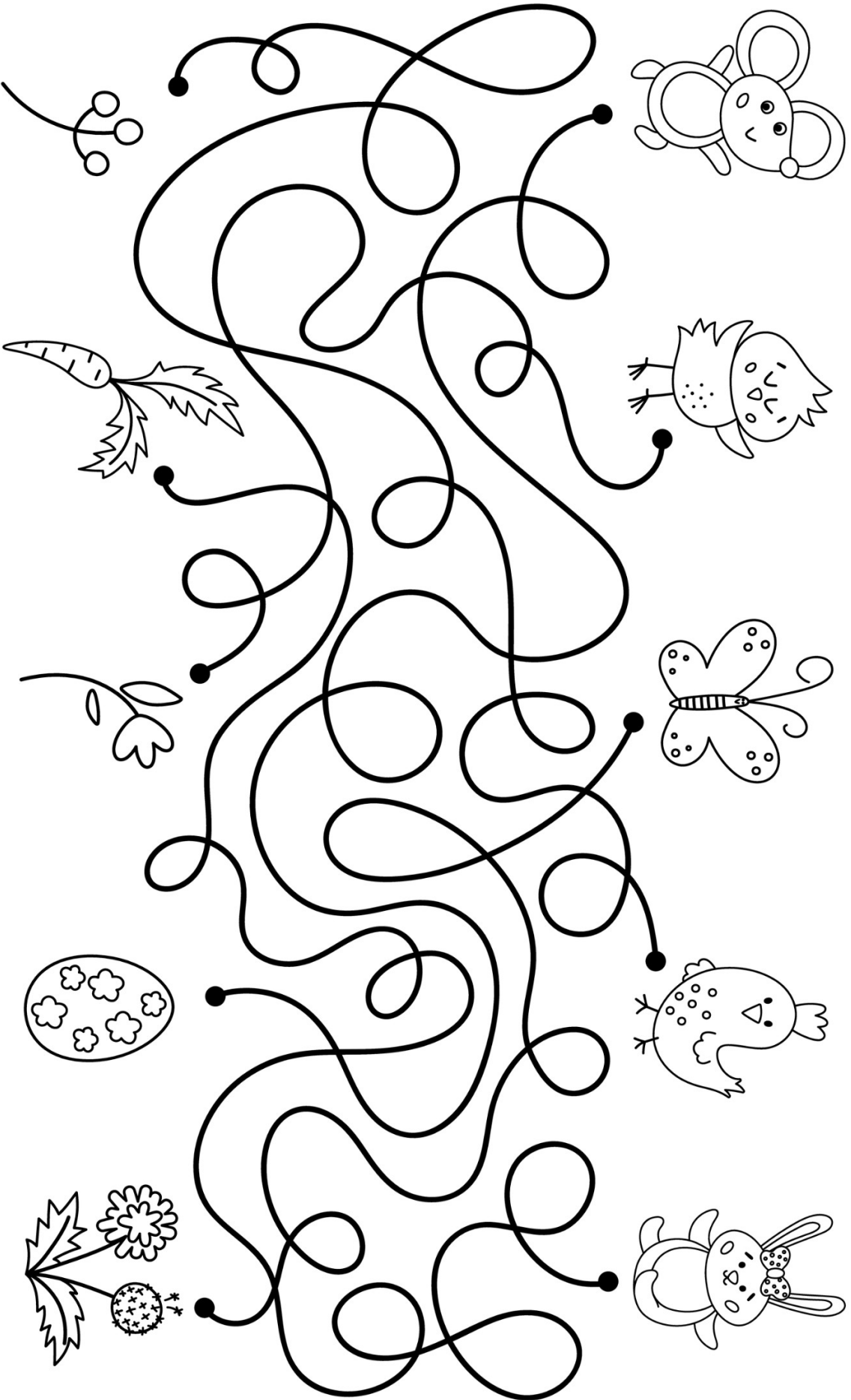

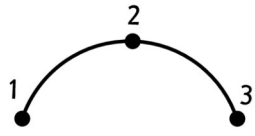

# Connect the Dots

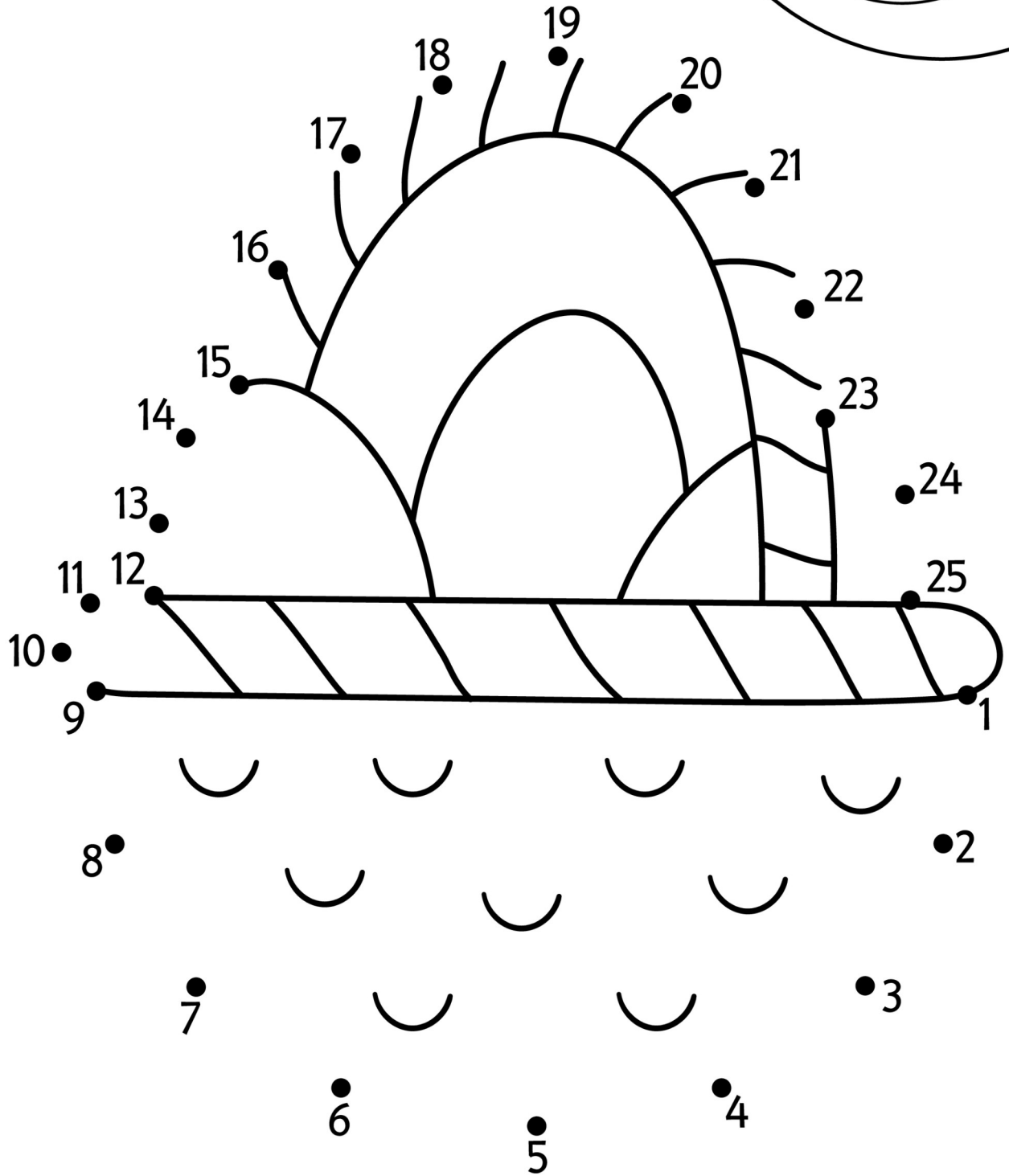
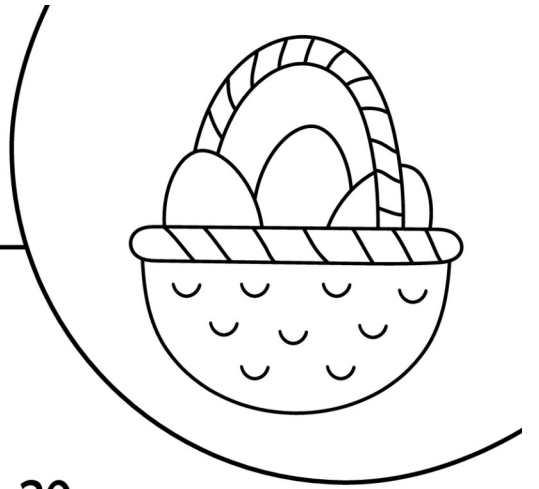



# What comes next?

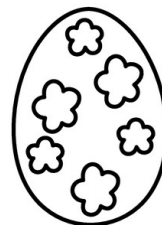
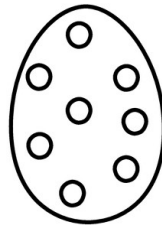
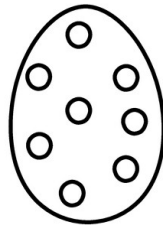
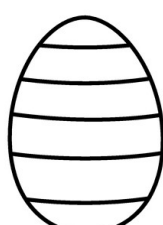
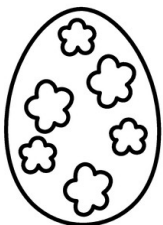
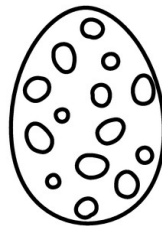
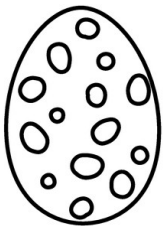
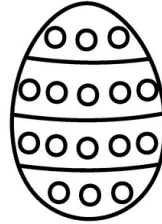
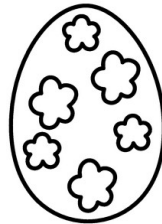
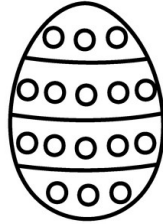
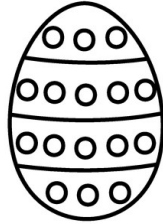
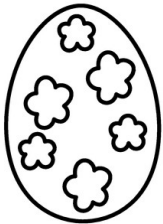
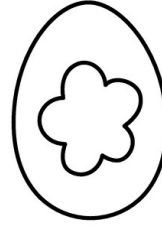
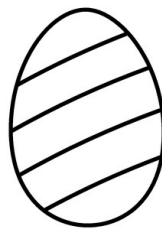
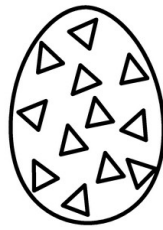
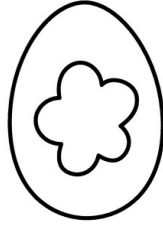
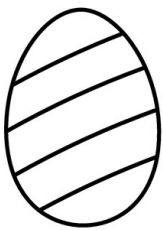
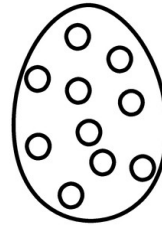
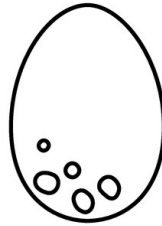
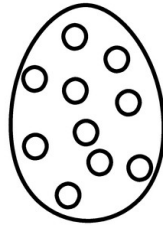
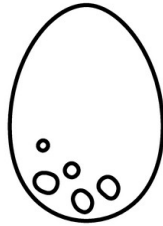
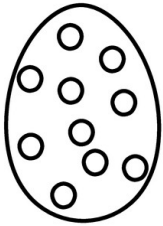
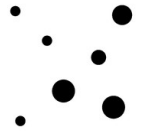

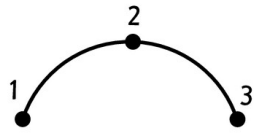

# Connect the Dots

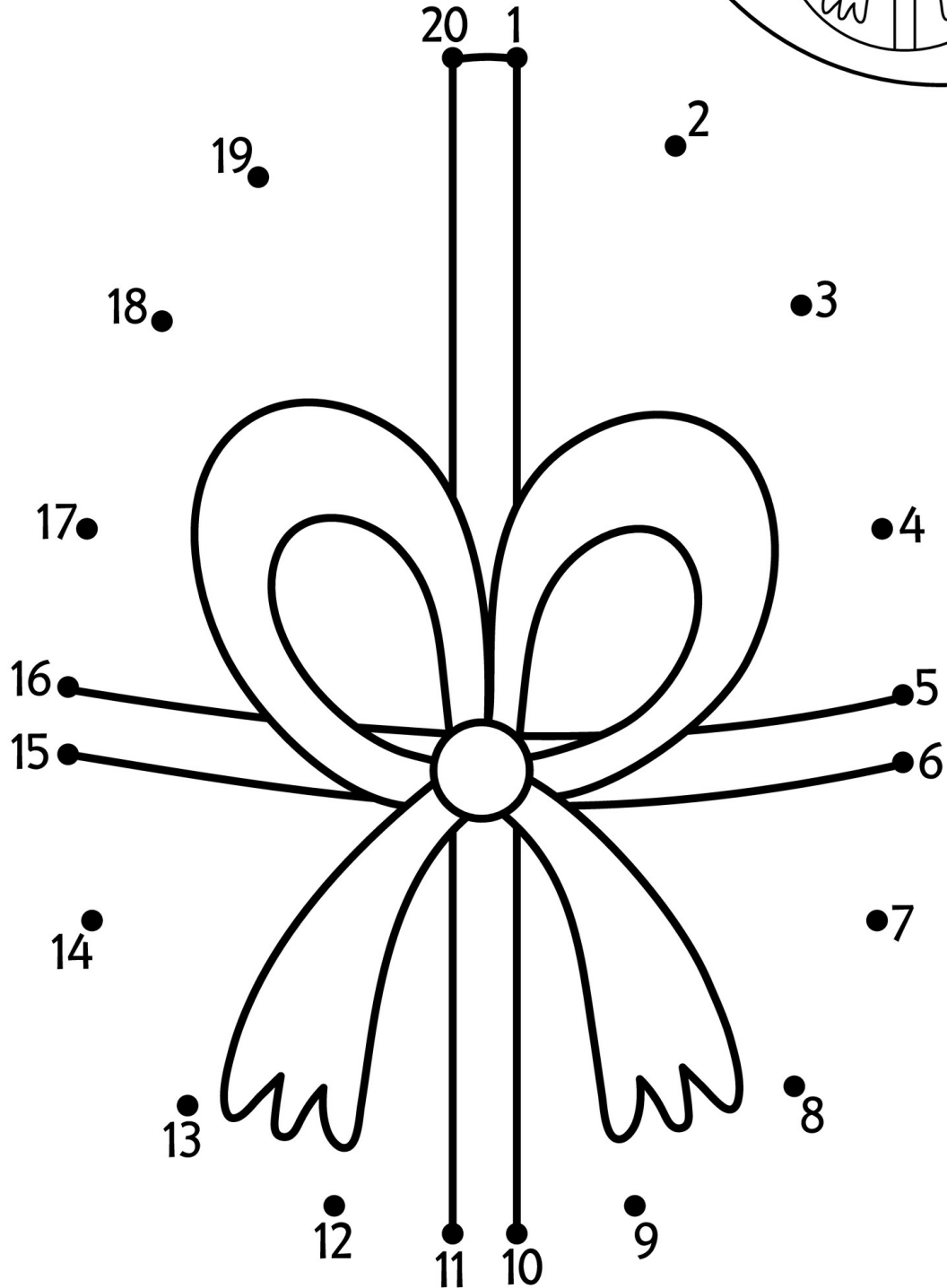
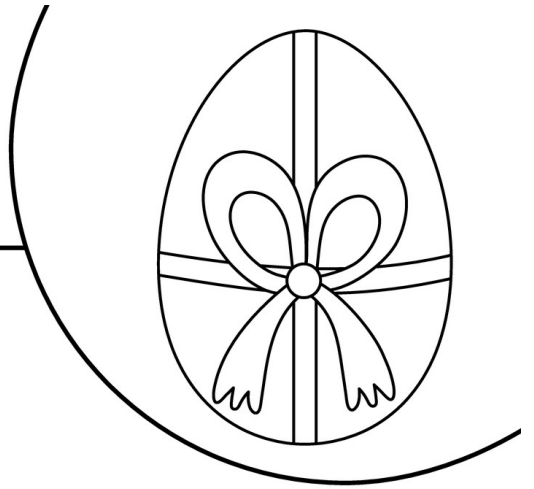



# HOW MANY EGGS?

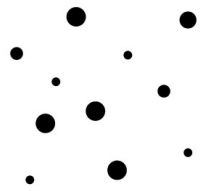

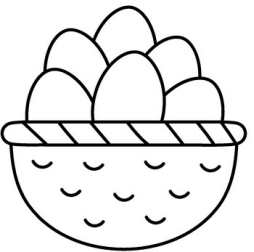
$3 + 3 = \square$  

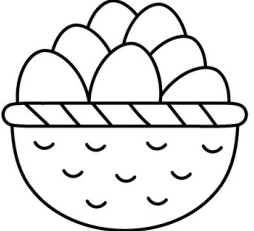
$5 + 2 = \square$  

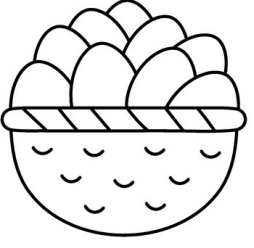
$3 + 6 = \square$  

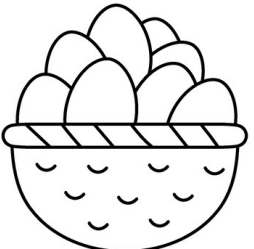
$4 + 4 = \square$  

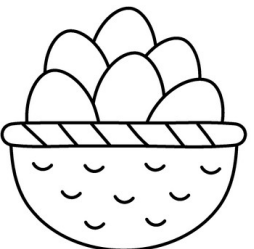
$4 + 2 = \square$  



# Whose carrot?

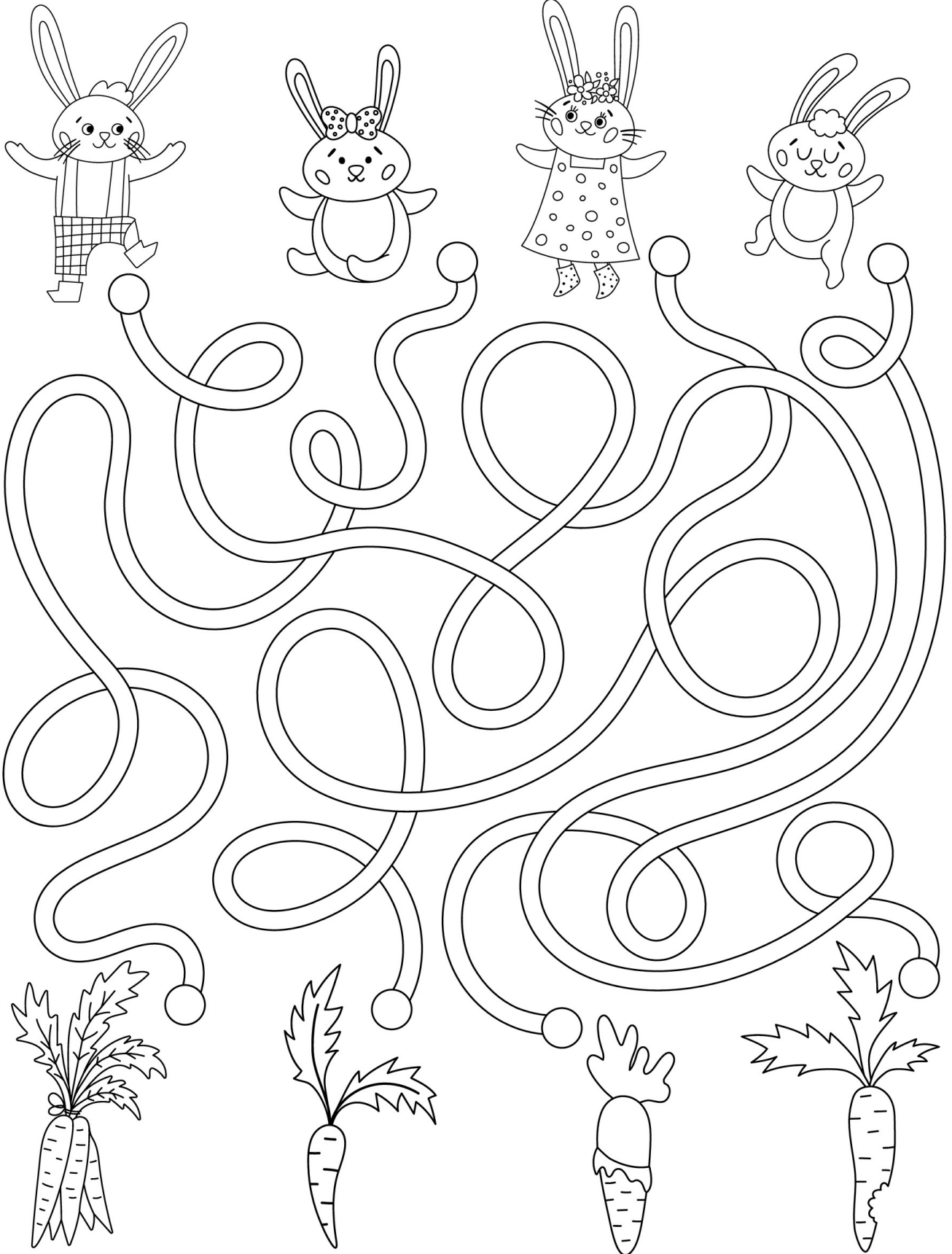
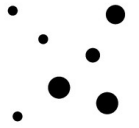



# What comes next?

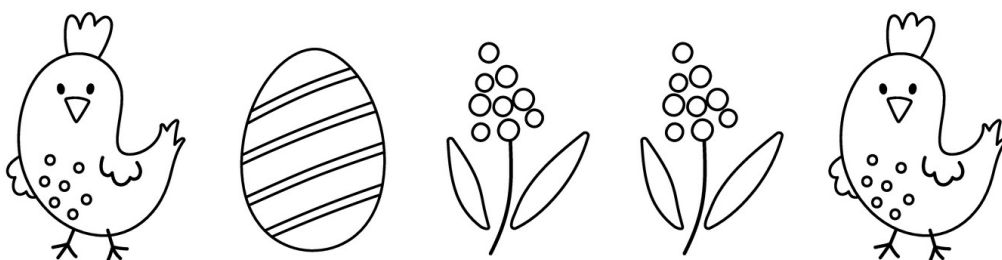
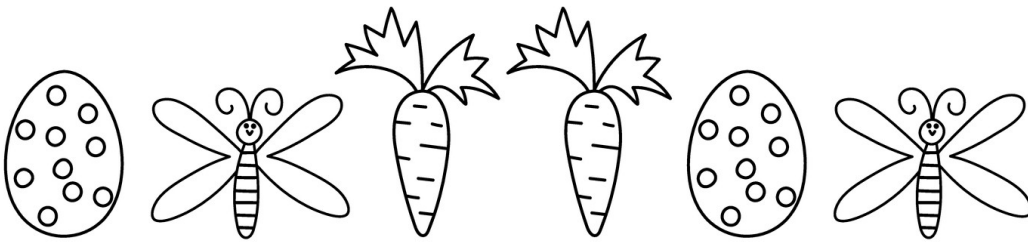
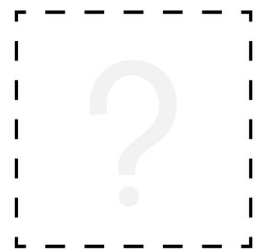
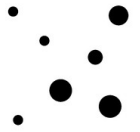





# I SPY

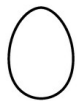
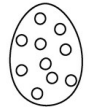
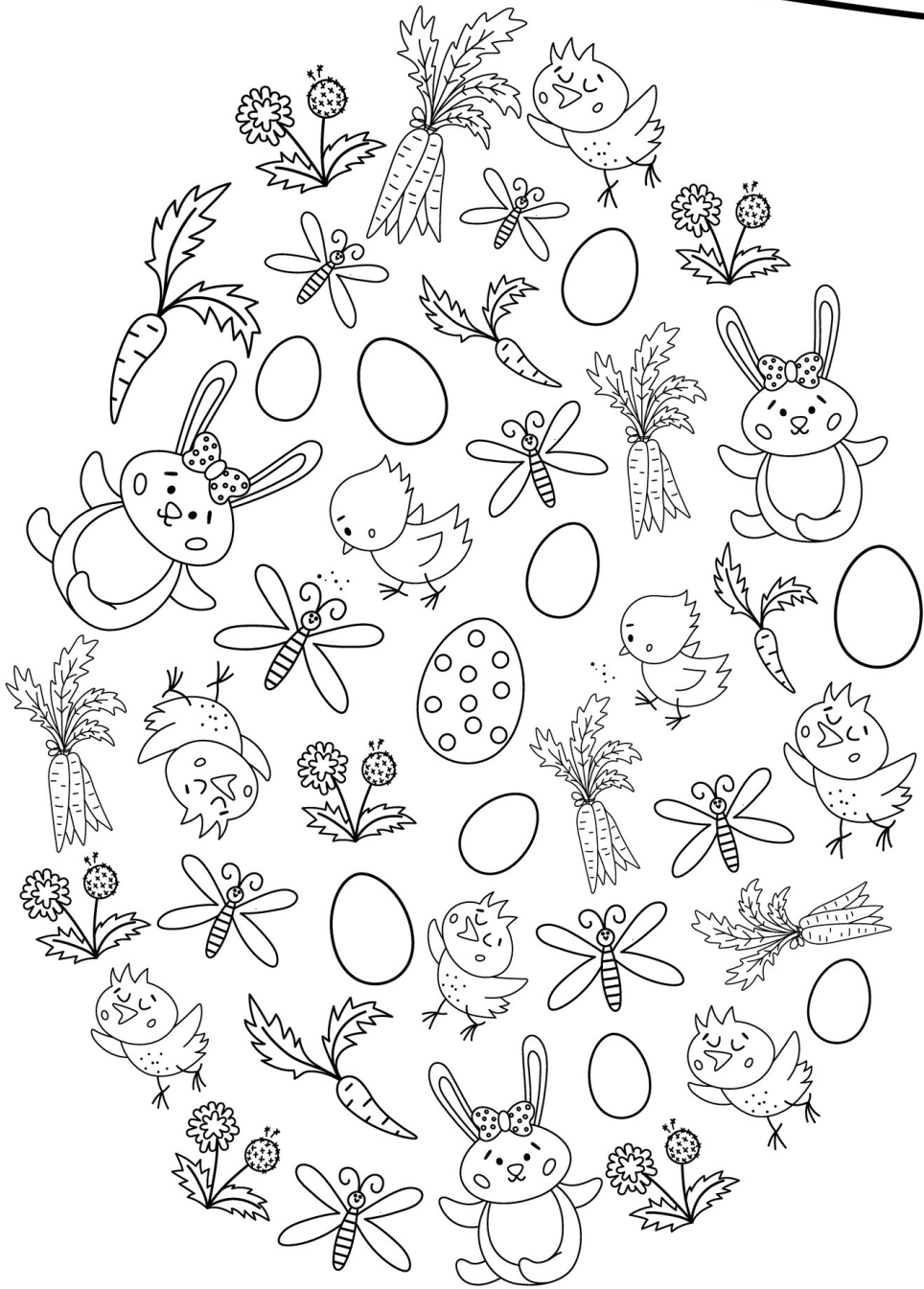



# FIND THE WAY OUT OF THE EGG

